

LED **JBL** SOLAR CONTROL

DE

UK

FR

MANUAL



5 X AUTO PROGRAM



Available on the
App Store

Get it on
Google play

Quick Guide

LED **JBL** SOLAR CONTROL







Original Betriebsanleitung JBL LED SOLAR CONTROL

Nicht vergessen: Registrieren Sie sich für die erweiterte 2 + 2 Jahre Garantie unter www.jbl.de/service

DE

UK

FR

1. Benutzerhinweise

Vor Inbetriebnahme müssen Sie die Betriebsanleitung vollständig gelesen und verstanden haben. Die Betriebsanleitung ist ein Bestandteil des Produktes, muss gut aufbewahrt und bei Weitergabe des Gerätes dem Produkt beigelegt werden. Eine ausführliche Anleitung ist unter <https://www.jbl.de/qr/100360> verfügbar

2. Einsatzgebiet

Dieses Gerät darf ausschließlich zur Steuerung der LED Leuchten **JBL LED SOLAR** mit der bereitgestellten App verwendet werden. Die Verwendung nicht vom Hersteller empfohlener Zubehörteile kann zu gefährlichen Situationen und Verlust der Garantie führen. Die in der Betriebsanleitung genannten Bedingungen sind einzuhalten.

3. Sicherheitshinweise

HINWEIS

Dieses Gerät kann von Kindern über 8 Jahren, Menschen mit eingeschränkten körperlichen, sensorischen oder mentalen Fähigkeiten, sowie unerfahrenen Menschen unter Aufsicht verwendet werden, sofern sie die Funktionsweise des Geräts verstanden haben und sich möglicher Gefahren bewusst sind.

WARNUNG!

Verschluckbare Kleinteile - Erstickungsgefahr für Kinder

Von Kindern unter 3 Jahren fernhalten.

Gerät führt Strom - Verletzungsgefahr durch Stromschlag

- Gerät nur in Räumen und außerhalb des Aquarium bzw. der Aquarienabdeckung installieren. Vor Inbetriebnahme auf sichere Installation des Gerätes prüfen.
- Kontakt mit Wasser oder anderen Flüssigkeiten vermeiden. Wenn stromführende Teile des Gerätes nass werden, sofort vom Netz trennen.
- Gerät nicht verwenden, wenn Kabel, Stecker oder Gehäuse beschädigt sind. Das Gerät kann nicht geöffnet werden und muss bei Beschädigung entsorgt werden.

VORSICHT!

Gefahr von Sachschäden

- Bei der Installation, Arbeiten am Gerät oder im Aquarium Gerät vom Stromnetz trennen.
- Kinder unter 8 Jahren sollten das Gerät nicht bedienen.



4. Installation

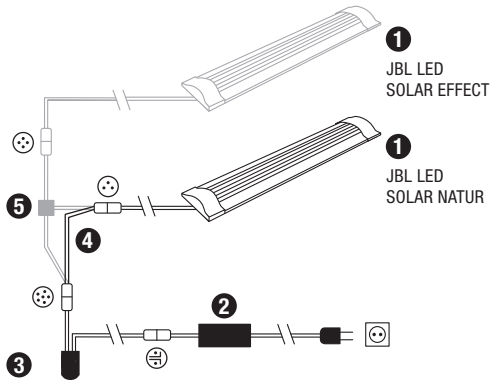

- 1 Leuchten
- 2 Netzteil
- 3 LED-Controller (ersetzt den IR-Controller der JBL SOLAR NATUR)
- 4 Verbindungskabel (nur LED SOLAR NATUR)
- 5 Kabelweiche (JBL SOLAR NATUR + JBL SOLAR EFFECT)

5. Bedienung der App Download:



Controller verbinden:

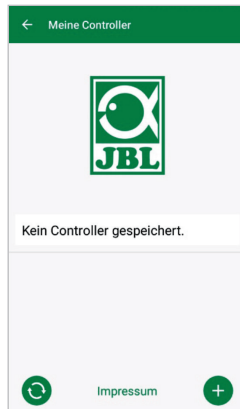

Controller hinzufügen (Controllernamen: JBL_XXXX, Standardpasswort: 12345678).



Nur iPhone: Controller in Einstellungen des iPhones verbinden.



Liste aktualisieren.



Zurück.

JBL_XXXX

Kurz drücken: Handy mit Controller verbinden.
Lang drücken: Gespeicherten Controller löschen.



Themenaquarien – Automatische Programme:

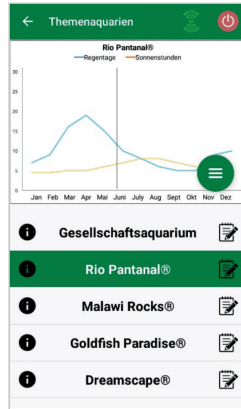

LED ein/aus.



Controller verbunden/getrennt.



Menü: Wechseln zu Manuellem Modus oder Einstellungen.



Information zum Themenaquarium (Weiterleitung erfordert Einbinden des Controllers in das Heimnetzwerk und Internetzugang).



Einstellungen: Sonnenaufgang verschieben, Beleuchtungspause hinzufügen oder Blitze in der Nacht deaktivieren.



Einstellungen aktivieren/deaktivieren.

DE

UK

FR

Manueller Modus:

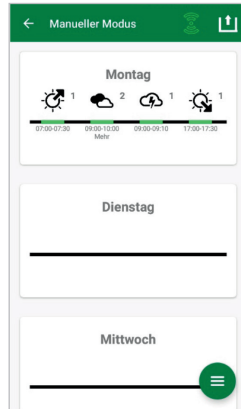

Kurz drücken: Tag bearbeiten.
Lang drücken: Tag kopieren.



Sonnenaufgang bearbeiten.



Sonnenuntergang bearbeiten.



Wolken bearbeiten.



Blitze bearbeiten.



Manuelles Programm auf Controller übertragen.



Menü: Wechseln zu Themenaquarien oder Einstellungen.

Einstellungen:



Meine Beleuchtung

Auswahl: Alleiniger Betrieb der JBL LED SOLAR NATUR oder zusammen mit JBL LED SOLAR EFFECT.

Akklimatisierung



Akklimatisierung ein/ausschalten (Bei Beleuchtungsumstellung zur Eingewöhnung der Aquarienbewohner).

Mein Controller

Controllernamen oder -passwörter ändern.

Mein Netzwerk

Controller in das Heimnetzwerk einbinden (erforderlich für Internetverbindung). Verbinden Sie Ihr Smartphone anschließend mit dem Heimnetzwerk.





6. Entsorgung



Dieses Gerät und alle dazu gehörenden Komponenten dürfen nicht mit dem normalen Hausmüll entsorgt werden. Beachten Sie die örtlichen Entsorgungsvorschriften für Elektrogeräte.

7. Technische Daten

Artikel Nummer: 6191800

Max. 10,5A (NATUR 144W, 6A / EFFEKT 108W, 4,5A)

Netzspannung 24V DC

Standby Betrieb <0,5 W

Frequenzband 2412 bis 2484 GHz

Maximale Sendeleistung <20 dBm

Funkreichweite (Freifeld) 30 m

Umgebungsbedingungen:

Temperatur (Betrieb): -20°C...40°C

Temperatur (Aufbewahrung): -20°C...40°C

Relative Luftfeuchtigkeit: 5-95% (keine Kondensation)



Hiermit erklärt JBL GmbH & Co. KG, dass der Funkanlagentyp „JBL LED SOLAR CONTROL“ der Richtlinie 2014/53/EU entspricht. Der vollständige Text der EU-Konformitätsbewertung ist unter <https://www.jbl.de/qr/100360> verfügbar



Translation of the German original operating instructions JBL LED SOLAR CONTROL

Don't forget: register for the extended 2 + 2 year guarantee under www.jbl.de/en/service

DE

UK

FR

1. User instructions

Please read and understand the operating instructions in their entirety before use. The operating instructions are an integral part of the product, must be kept in a safe place and must be enclosed with the product when the device is passed on. Detailed instructions are available at <https://www.jbl.de/qr/100360>.

2. Scope of application

This device may only be used to steer the LED luminaires JBL LED SOLAR with its respective app. The use of accessories not recommended by the manufacturer can lead to dangerous situations and loss of warranty. The conditions specified in the operating instructions must be observed.

3. Safety instructions

NOTE

This device can be used under supervision by children over the age of 8, people with physical, sensory or mental impairments, and by people with no previous experience, provided they understand the operation of the device and are aware of possible hazards.

WARNING!

Swallowable small parts - danger of suffocation for children

Keep away from children under 3 years.

Current-carrying device - risk of injury by electric shock

- Only ever install the unit indoors, outside the aquarium or aquarium cover. Before operating check the unit is safely installed.
- Avoid contact with water or other liquids. If live parts of the unit become wet, immediately disconnect them from the mains supply.
- Do not use the unit if the cable, plug or housing are damaged. The unit cannot be opened and must be disposed of if damaged.

CAUTION!

Danger of property damage

- Disconnect the appliance from the mains supply during installation, work on the appliance or in the aquarium.
- Children under the age of 8 should not operate the unit.



4. Installation

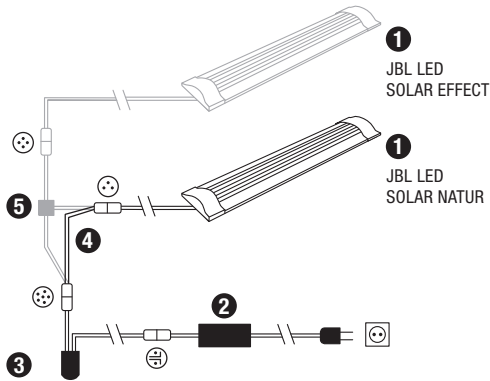

- 1 Lights
- 2 Power Supply
- 3 LED controller (replaces the JBL SOLAR NATUR IR controller)
- 4 Connecting cable (only LED SOLAR NATUR)
- 5 Cable switch (JBL SOLAR NATUR + JBL SOLAR EFFECT)

5. Operating the app

Download:



Connecting the controller:

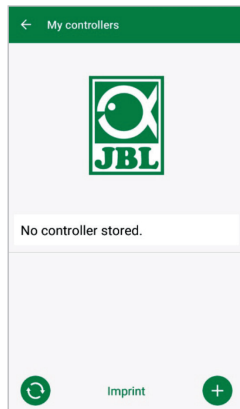

Add controller (controller name: JBL_XXXX, default password: 12345678).



iPhone only: connect the controller to the iPhone's settings.



Update list.



Back.

JBL_XXXX

Press briefly: connect mobile phone to controller.
Press and hold: delete the saved controller.



Themed aquariums - automatic programmes:

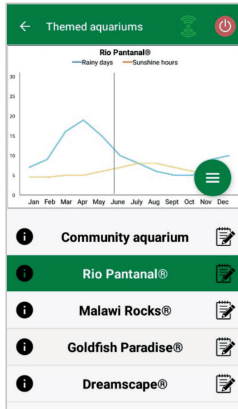

LED on/off.



Controller connected/disconnected.



Menu: switch to Manual Mode or Settings.



Information about the themed aquarium (Forwarding requires controller to be integrated into home network and internet access).



Settings: move sunrise, add lighting pause or deactivate lighting at night.



Activate/deactivate settings.

DE

UK

FR

Manual Programming:

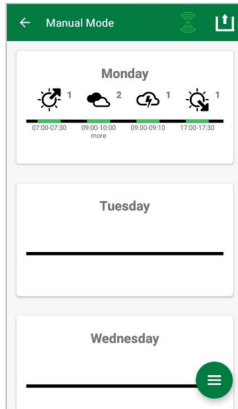

Press briefly: edit day.
Press and hold: copy day.



Edit sunrise.



Edit sunset.



Edit clouds.



Edit lightning.



Transfer manual programme to controller.



Menu: switch to themed aquariums or settings.

Settings:

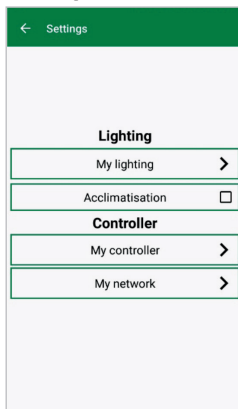

My lighting

Selection: only operation of the JBL LED SOLAR NATUR or together with JBL LED SOLAR EFFECT.

Acclimatisation

Switch acclimatisation on/off (to acclimatised aquarium inhabitants when lighting is changed).



My controller

Change controller name or password.

My network

Integrate the controller into the home network (required for Internet connection).
Then connect the smartphone to the home network.





6. Disposal



Do not dispose of this appliance and all its components in your general household waste. Comply with local disposal regulations for electric appliances.

7. Technical Data

Article number: 6191800

Max. 10.5A, (NATUR 144W, 6A / EFFECT 108W, 4.5A)

Mains voltage 24V DC

Standby operation <0.5 W

Frequency band 2412 bis 2484 GHz

Maximum transmission power <20 dBm

Radio range (free field) 30 m

Environmental conditions:

Temperatur (operation): -20°C...40°C

Temperatur (storage): -20°C...40°C

Relative humidity: 5-95% (no condensation)



JBL GmbH & Co. KG hereby declares that the radio system type „JBL LED SOLAR CONTROL“ complies with Directive 2014/53/EU. The complete text of the EU conformity assessment is available at <https://www.jbl.de/qr/100360>.





Traduction du mode d'emploi original en allemand JBL LED SOLAR CONTROL

N'oubliez pas: enregistrez-vous pour l'extension de garantie 2 + 2 à l'adresse www.jbl.de/service

DE

UK

FR

1. Instructions générales

1. Avant de mettre l'appareil en marche, vous devez avoir entièrement lu et compris le mode d'emploi. Le mode d'emploi fait partie intégrante du produit. Veillez à bien le conserver, dans un endroit facilement accessible. En cas de transmission à des tiers, veuillez à joindre le présent mode d'emploi. Un mode d'emploi plus détaillé est disponible sur: <https://www.jbl.de/qr/100360>

2. Domaine d'utilisation

Cet appareil doit uniquement être utilisé pour le contrôle des rampes d'éclairage LED JBL LED SOLAR avec l'application mise à disposition. L'utilisation d'accessoires non recommandés par le fabricant peut conduire à des situations dangereuses et à la perte de la garantie. Les conditions générales mentionnées dans ce mode d'emploi sont à respecter.

3. Consignes de sécurité

CONSEIL

Cet appareil ne peut être utilisé que sous surveillance par des enfants âgés de plus de 8 ans, des personnes aux capacités physiques, sensorielles ou mentales limitées, ou des personnes inexpérimentées. Ces personnes devront avoir été initiées au mode de fonctionnement de l'appareil et être conscientes des risques présentés par son utilisation.

ATTENTION!

Petites pièces pouvant s'avaler facilement – Risques d'étouffement pour les enfants

A tenir hors de la portée des enfants de moins de 3 ans.

L'appareil conduit du courant – Danger de blessure par électrocution

- L'appareil doit être utilisé uniquement à l'intérieur et en dehors de l'aquarium ou de la galerie de déclairage de l'aquarium. Avant la mise en service, vérifiez que l'appareil est correctement installé.
- Eviter tout contact avec de l'eau ou d'autres liquides. Si des pièces conductrices viennent en contact sont mouillées, débranchez immédiatement de l'alimentation électrique.
- Ne pas utiliser l'appareil si le câble d'alimentation, la fiche ou le boîtier sont endommagés. L'appareil ne peut pas s'ouvrir. En cas d'endommagement vous devez le porter à la déchetterie

PRUDENCE!

Danger de dégâts matériels

- Débranchez toujours l'appareil du secteur électrique lors de son installation ou d'opérations à effectuer sur l'appareil ou dans l'aquarium.
- L'appareil ne doit pas être utilisé par des enfants de moins de 8 ans.



4. Installation

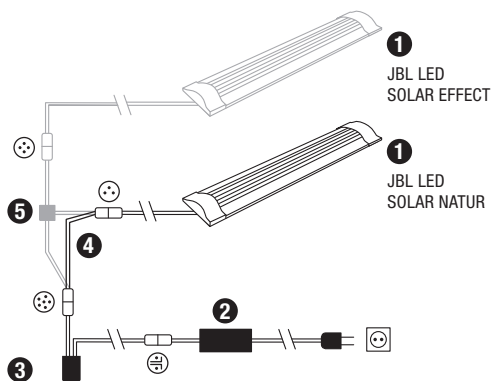

- 1 Rampes
- 2 Alimentation électrique
- 3 Contrôleur LED (remplace le contrôleur IR du JBL SOLAR NATUR)
- 4 Câble de connection (uniquement LED SOLAR NATUR)
- 5 Câble de connection en Y (JBL SOLAR NATUR + JBL SOLAR EFFECT)

5. Utilisation de l'Application

Téléchargement:



Connexion du Contrôleur:

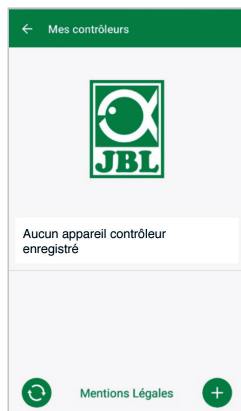

Ajouter le Contrôleur (Nom du contrôleur: JBL_XXXX, Mot de passe standard: 12345678).



Uniquement iPhone: connecter le Contrôleur dans les paramètres de votre iPhone



Actualiser la liste.



Retour.

Appuyer brièvement: connecter le Contrôleur avec le téléphone portable.





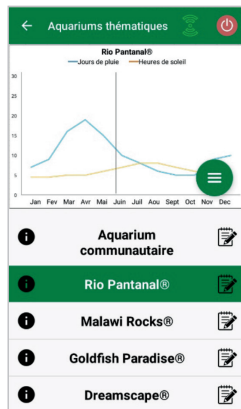

Appuyer longuement: effacer le Contrôleur mémorisé

JBL_XXXX



Aquariums thématiques – Programmes automatiques:



-  LED marche/arrêt.
-  Contrôleur connecté/déconnecté
-  Menu: Changer au Mode Manuel ou paramètres de réglages
-  Information sur les aquariums thématiques (Un transfert nécessite une intégration du Contrôleur dans le réseau et l'accès internet).
-  Réglages: Décaler le lever du soleil, ajouter une pause lumière ou désactiver les éclairés pendant la nuit.
-  Réglages activer/désactiver.









DE

UK

FR

Mode Manuel:



-  Appuyer brièvement: Adapter le jour
-  Appuyer longuement: Copier le jour
-  Adapter le lever du soleil.
-  Adapter le coucher du soleil.
-  Adapter les nuages.
-  Adapter les éclairés.
-  Retransmettre le mode manuel sur le Contrôleur.
-  Menu: Changer aux Aquariums thématiques ou paramètres de réglages.

Réglages:



- Mon éclairage** Choix: utilisation unique de JBL LED SOLAR NATUR oder avec JBL LED SOLAR EFFECT.
- Acclimatation** Acclimatation marche/arrêt (lors d'un changement d'éclairage pour l'accoutumance des habitants de l'aquarium).
 /
- Mon Contrôleur** Modifier le nom du Contrôleur et Mot de passe.
- Mon réseau** Connecter le Contrôleur au réseau (indispensable pour une connection internet). Ensuite connecter votre Smartphone au réseau.





6. Traitement des déchets



Il est interdit de jeter cet appareil ou ses composants dans les ordures ménagères courantes. Respectez les réglementations locales en matière de déchets des appareils électriques.

7. Données techniques

Numéro d'article: 6191800

Max. 10,5A, (NATUR 144W, 6A / EFFECT 108W, 4,5A)

Tension de service 24V DC

Consommation en veille <0,5 W

Bande de fréquences 2412 à 2484 GHz

Energie d'émission maximale <20 dBm

Portée (rase campagne) 30 m

Conditions d'environnement:

Température (en fonction): -20°C...40°C

Température (stockage): -20°C...40°C

Humidité relative: 5-95% (pas de condensation)



La société JBL GmbH & Co. KG garantit que l'installation de type „JBL LED SOLAR CONTROL“ répond aux exigences de la directive 2014/53/EU. Le texte complet de l'évaluation de la conformité EU est disponible sous l'adresse <https://www.jbl.de/qr/100360>



Notizen

DE

UK

FR





LED **JBL**

SOLAR CONTROL



JBL GmbH & Co. KG
Dieselstr. 3
67141 Neuhofen
Germany
www.JBL.de

13 61918 00 0 V03